



Visualisation; Diagnostics

Easy to Configure

Programming IEC 61131-3

Rapid Installation

PNOZ m EF 8DI4DO

PILZ
THE SPIRIT OF SAFETY

- ▶ Configurable, safe small controllers PNOZmulti 2

This document is the original document.

All rights to this documentation are reserved by Pilz GmbH & Co. KG. Copies may be made for the user's internal purposes. Suggestions and comments for improving this documentation will be gratefully received.

Source code from third-party manufacturers or open source software has been used for some components. The relevant licence information is available on the Internet on the Pilz homepage.

Pilz®, PIT®, PMI®, PNOZ®, Primo®, PSEN®, PSS®, PVIS®, SafetyBUS p®, SafetyEYE®, SafetyNET p®, the spirit of safety® are registered and protected trademarks of Pilz GmbH & Co. KG in some countries.



SD means Secure Digital

| | | |
|-----------|--|-----------|
| 1 | Introduction | 5 |
| 1.1 | Validity of documentation | 5 |
| 1.2 | Using the documentation | 5 |
| 1.3 | Definition of symbols | 5 |
| 2 | Overview | 7 |
| 2.1 | Scope of supply | 7 |
| 2.2 | Unit features | 7 |
| 2.3 | Front view | 8 |
| 3 | Safety | 9 |
| 3.1 | Intended use | 9 |
| 3.2 | System requirements | 9 |
| 3.3 | Safety regulations | 9 |
| 3.3.1 | Safety assessment | 9 |
| 3.3.2 | Use of qualified personnel | 10 |
| 3.3.3 | Warranty and liability | 10 |
| 3.3.4 | Disposal | 10 |
| 3.3.5 | For your safety | 10 |
| 4 | Function description | 11 |
| 4.1 | Integrated protection mechanisms | 11 |
| 4.2 | Functions | 11 |
| 4.3 | System reaction time | 11 |
| 4.4 | Block diagram | 11 |
| 5 | Installation | 12 |
| 5.1 | General installation guidelines | 12 |
| 5.2 | Dimensions in mm | 12 |
| 5.3 | Connecting the base unit and expansion modules | 13 |
| 6 | Commissioning | 14 |
| 6.1 | General wiring guidelines | 14 |
| 6.2 | Connection | 14 |
| 6.3 | Download modified project to the PNOZmulti system | 16 |
| 7 | Operation | 17 |
| 7.1 | LED indicators | 17 |
| 8 | Technical details | 18 |
| 8.1 | Safety characteristic data | 21 |
| 8.2 | Classification according to ZVEI, CB24I | 22 |
| 9 | Supplementary data | 23 |
| 9.1 | Permitted ambient temperature T_{amb} dependent on the total current I_{sum} | 23 |
| 10 | Order reference | 24 |
| 10.1 | Product | 24 |

| | | |
|------|-------------------|----|
| 10.2 | Accessories | 24 |
|------|-------------------|----|

1 Introduction

1.1 Validity of documentation

This documentation is valid for the product PNOZ m EF 8DI4DO. It is valid until new documentation is published.

This operating manual explains the function and operation, describes the installation and provides guidelines on how to connect the product.

1.2 Using the documentation

This document is intended for instruction. Only install and commission the product if you have read and understood this document. The document should be retained for future reference.

1.3 Definition of symbols

Information that is particularly important is identified as follows:



DANGER!

This warning must be heeded! It warns of a hazardous situation that poses an immediate threat of serious injury and death and indicates preventive measures that can be taken.



WARNING!

This warning must be heeded! It warns of a hazardous situation that could lead to serious injury and death and indicates preventive measures that can be taken.



CAUTION!

This refers to a hazard that can lead to a less serious or minor injury plus material damage, and also provides information on preventive measures that can be taken.



NOTICE

This describes a situation in which the product or devices could be damaged and also provides information on preventive measures that can be taken. It also highlights areas within the text that are of particular importance.



INFORMATION

This gives advice on applications and provides information on special features.

2 Overview

2.1 Scope of supply

- ▶ Expansion module PNOZ m EF 8DI4DO
- ▶ Jumper

2.2 Unit features

Application of the product PNOZ m EF 8DI4DO:

Expansion module for connection to a base unit from the PNOZmulti 2 system.

The product has the following features:

- ▶ Can be configured in the PNOZmulti Configurator
- ▶ Semiconductor outputs:
 - 4 safety outputs
 - Depending on the application, up to PL e of EN ISO 13849-1 and up to SIL CL 3 of EN IEC 62061
- ▶ 8 inputs for connecting, for example:
 - E-STOP pushbutton
 - Two-hand button
 - Safety gate limit switch
 - Start button
 - Light beam devices
 - Scanner
 - Enabling switch
 - PSEN
 - Operating mode selector switch
- ▶ LED for:
 - Error messages
 - Diagnostics
 - Supply voltage
 - Output circuits
 - Input circuits
- ▶ Test pulse outputs used to monitor shorts across the inputs
- ▶ Monitoring of shorts between the safety outputs
- ▶ Plug-in connection terminals:
 - Either spring-loaded terminal or screw terminal available as an accessory (see order reference)
- ▶ Please refer to the document "PNOZmulti System Expansion" for details of the base units PNOZmulti 2 that can be connected.

2.3 Front view

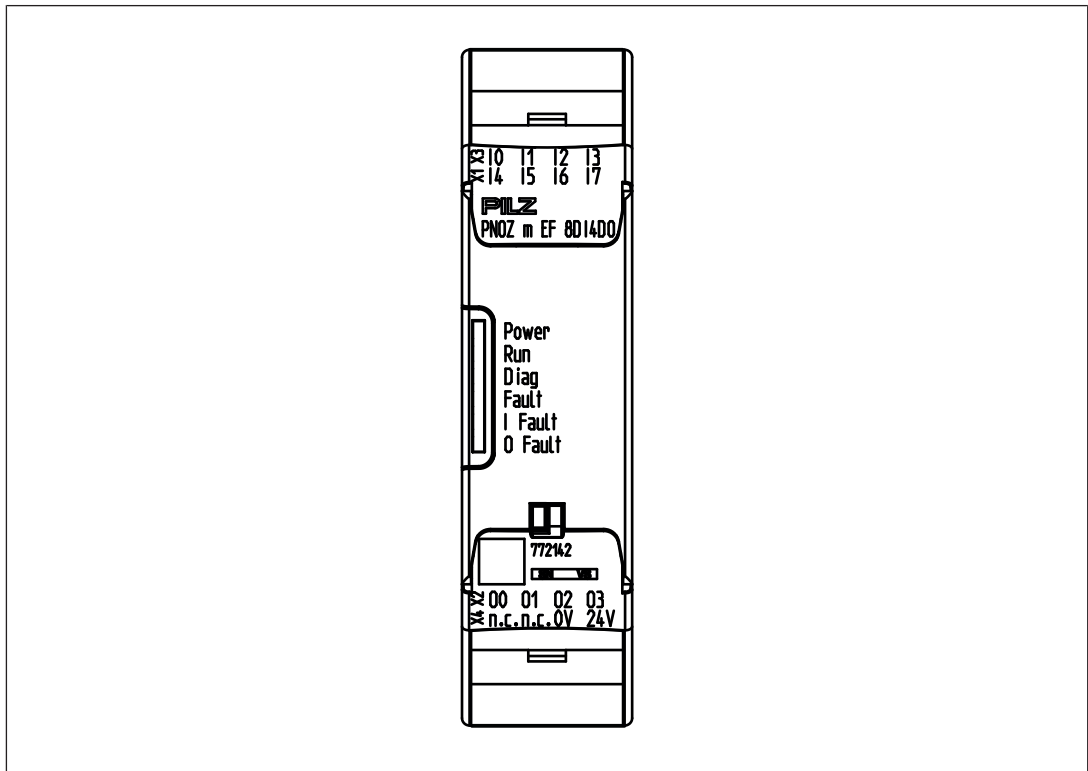

Key:

- ▶ 0 V, 24 V: Supply connections
- ▶ Inputs I0 – I7
- ▶ Outputs O0 – O3
- ▶ LEDs:
 - POWER
 - Run
 - Diag
 - Fault
 - I Fault
 - O Fault

3 Safety

3.1 Intended use

The expansion module may only be connected to a base unit from the configurable system PNOZmulti 2 (please refer to the document "PNOZmulti System Expansion" for details of the base units that can be connected).

The configurable system PNOZmulti 2 is used for the safety-related interruption of safety circuits and is designed for use in:

- ▶ Emergency stop equipment
- ▶ Safety circuits in accordance with VDE 0113 Part 1 and EN 60204-1
- ▶ The product PNOZ m EF 8DI4DO meets the requirements of the standards EN 81-20, EN 81-22 and EN 81-50, harmonised under the Lifts Directive 2014/33/EU, and the requirements of the standard EN 115-1, harmonised under the Machinery Directive 2006/42/EC.
- ▶ The programmable safety system should be installed in a protected environment that meets at least the requirements of pollution degree 2.
Example: Protected inside space or control cabinet with protection type IP54 and corresponding air conditioning.

The product PNOZ m EF 8DI4DO can be used in furnaces in accordance with EN 298.

The following is deemed improper use in particular

- ▶ Any component, technical or electrical modification to the product,
- ▶ Use of the product outside the areas described in this manual,
- ▶ Use of the product outside the technical details (see [Technical details](#)  18).



NOTICE

EMC-compliant electrical installation

The product is designed for use in an industrial environment. The product may cause interference if installed in other environments. If installed in other environments, measures should be taken to comply with the applicable standards and directives for the respective installation site with regard to interference.

3.2 System requirements

Please refer to the "Product Modifications PNOZmulti" document in the "Version overview" section for details of which versions of the base unit and PNOZmulti Configurator can be used for this product.

3.3 Safety regulations

3.3.1 Safety assessment

Before using a device it is necessary to perform a safety assessment in accordance with the Machinery Directive.

Functional safety is guaranteed for the product as a single component. However, this does not guarantee the functional safety of the overall plant/machine. In order to achieve the required safety level for the overall plant/machine, define the safety requirements for the plant/machine and then define how these must be implemented from a technical and organisational standpoint.

3.3.2 Use of qualified personnel

The products may only be assembled, installed, programmed, commissioned, operated, maintained and decommissioned by competent persons.

A competent person is someone who, because of their training, experience and current professional activity, has the specialist knowledge required to test, assess and operate the work equipment, devices, systems, plant and machinery in accordance with the general standards and guidelines for safety technology.

It is the company's responsibility only to employ personnel who

- ▶ Are familiar with the basic regulations concerning health and safety / accident prevention,
- ▶ Have read and understood the information provided in this description under "Safety",
- ▶ And have a good knowledge of the generic and specialist standards applicable to the specific application.

3.3.3 Warranty and liability

All claims to warranty and liability will be rendered invalid if

- ▶ The product was used contrary to the purpose for which it is intended,
- ▶ Damage can be attributed to not having followed the guidelines in the manual,
- ▶ Operating personnel are not suitably qualified,
- ▶ Any type of modification has been made (e.g. exchanging components on the PCB boards, soldering work etc.).

3.3.4 Disposal

- ▶ In safety-related applications, please comply with the mission time T_M in the safety-related characteristic data.
- ▶ When decommissioning, please comply with local regulations regarding the disposal of electronic devices (e.g. Electrical and Electronic Equipment Act).

3.3.5 For your safety

The unit meets all the necessary conditions for safe operation. However, you should always ensure that the following safety requirements are met:

- ▶ This operating manual only describes the basic functions of the unit. The expanded functions are described in the PNOZmulti Configurator's online help. Only use these functions once you have read and understood the documentations.
- ▶ Do not open the housing or make any unauthorised modifications.
- ▶ Please make sure you shut down the supply voltage when performing maintenance work (e.g. exchanging contactors).

4 Function description

4.1 Integrated protection mechanisms

The relay meets the following safety requirements:

- ▶ The circuit is redundant with built-in self-monitoring.
- ▶ The safety device remains effective in the case of a component failure.
- ▶ The safety outputs are tested periodically using a disconnection test.

4.2 Functions

The expansion module provides additional inputs and additional semiconductor outputs.

The function of the inputs and outputs on the control system depends on the safety circuit created using the PNOZmulti Configurator. A removable data medium is used to download the safety circuit to the base unit. The base unit has 2 microcontrollers that monitor each other. They evaluate the input circuits on the base unit and expansion modules and switch the outputs on the base unit and expansion modules accordingly.

The online help on the PNOZmulti Configurator contains descriptions of the operating modes and all the functions of the PNOZmulti control system, plus connection examples.

4.3 System reaction time

Calculation of the maximum reaction time between an input switching off and a linked output in the system switching off is described in the document "PNOZmulti System Expansion".

4.4 Block diagram

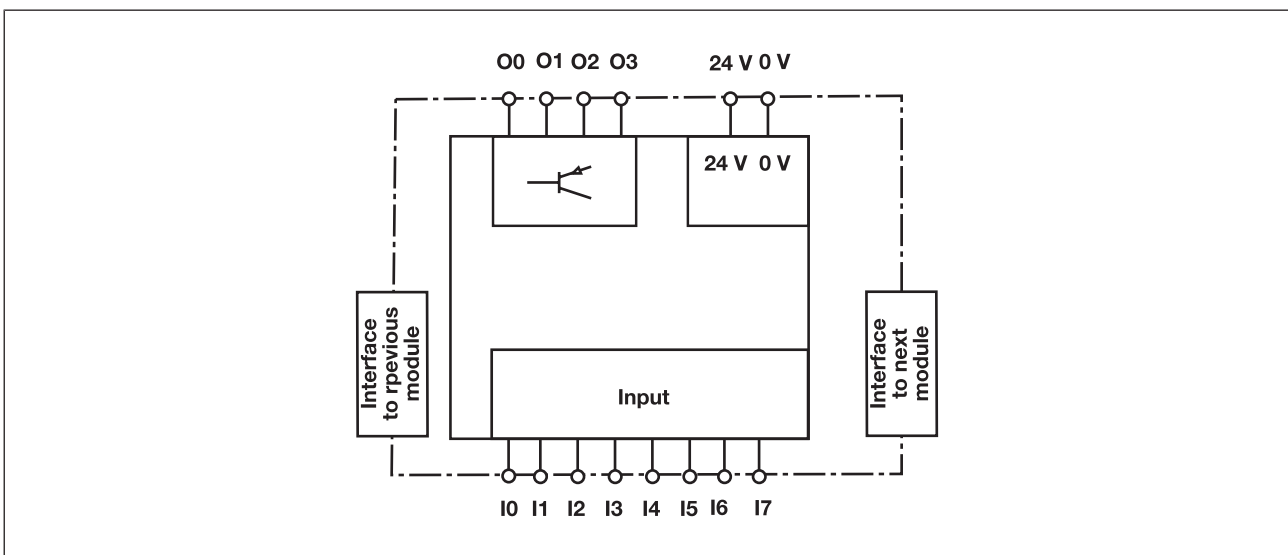

5 Installation

5.1 General installation guidelines

- ▶ The unit should be installed in a control cabinet with a protection type of at least IP54.
- ▶ Fit the safety system to a horizontal mounting rail. The venting slots must face upward and downward. Other mounting positions could damage the safety system.
- ▶ Use the locking elements on the rear of the unit to attach it to a mounting rail.
- ▶ In environments exposed to heavy vibration, the unit should be secured using a fixing element (e.g. retaining bracket or end angle).
- ▶ Open the locking slide before lifting the unit from the mounting rail.
- ▶ To comply with EMC requirements, the mounting rail must have a low impedance connection to the control cabinet housing.
- ▶ The ambient temperature of the PNOZmulti units in the control cabinet must not exceed the figure stated in the technical details. Air conditioning may otherwise be required.



NOTICE

Damage due to electrostatic discharge!

Electrostatic discharge can damage components. Ensure against discharge before touching the product, e.g. by touching an earthed, conductive surface or by wearing an earthed armband.

5.2 Dimensions in mm

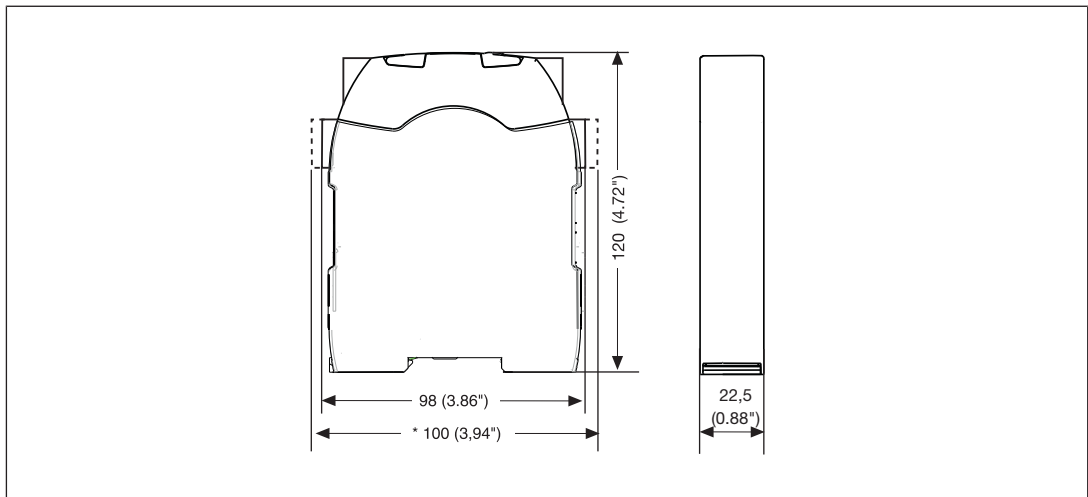

5.3 Connecting the base unit and expansion modules

Connect the base unit and the expansion modules as described in the operating manuals for the base modules.

- ▶ The terminator must be fitted to the last expansion module
- ▶ Install the expansion module in the position configured in the PNOZmulti Configurator.

The position of the expansion modules is defined in the PNOZmulti Configurator. The expansion modules are connected to the left or right of the base unit, depending on the type.

Please refer to the document "PNOZmulti System Expansion" for details of the number of modules that can be connected to the base unit and the module types.

6 Commissioning

6.1 General wiring guidelines

The wiring is defined in the circuit diagram of the PNOZmulti Configurator.

Please note:

- ▶ Information given in the [Technical details \[18\]](#) must be followed.
- ▶ The position of the expansion module is specified in the Hardware configuration of the PNOZmulti Configurator.
- ▶ Use copper wiring with a temperature stability of 75 °C.

6.2 Connection

| | |
|----------------|----|
| Supply voltage | DC |
| | |

Supply voltage

| Input circuit | Single-channel | Dual-channel |
|---|----------------|--------------|
| Example: E-Stop without detection of shorts across contacts | | |
| Example: E-Stop with detection of shorts across contacts | | |

Connection examples for the input circuit

| | | |
|---|--|--|
| <p>Redundant output</p> | | |
| <p>Single output</p> | | |
| <p>Single output with advanced fault detection*</p> | | |

Connection examples for semiconductor outputs

*Two loads may be connected to each safety output with advanced fault detection, even on applications in accordance with EN IEC 62061, SIL CL 3. Prerequisite: Feedback loop is connected, shorts across contacts and external power sources are excluded (e.g. through separate multicore cables). Please note that, in the event of an error in the feedback loop, the safety system switches to a safe condition and shuts down **all** the outputs.

| | |
|--|-------------------------|
| <p>Feedback loop</p> | <p>Redundant output</p> |
| <p>Contacts from external contactors</p> | |

Connection examples for feedback loop

6.3 Download modified project to the PNOZmulti system

As soon as an additional expansion module has been connected to the system, the project must be amended in the PNOZmulti Configurator and downloaded back into the base unit. Proceed as described in the operating manual for the base unit.



NOTICE



For the commissioning and after every user program change, you must check whether the safety devices are functioning correctly.





















7 Operation

The PNOZmulti system is ready for operation when the "POWER" and "RUN" LEDs on the base unit are lit continuously.

7.1 LED indicators

Legend

-  LED on
-  LED flashes
-  LED off

| LED | | | | | | Error |
|---|---|------|---|---|---|--|
| POWER | Run | Diag | Fault | IFault | OFault | |
| | | | | | | No supply voltage |
|  |  | | | | | Expansion module PNOZ m EF 8DI4DO running without error. |
|  | | | | | | Expansion module PNOZ m EF 8DI4DO is in a STOP condition. |
|  | | |  | | | Internal error on the expansion module PNOZ m EF 8DI4DO or on the overall system. Expansion module is in a safe condition. |
|  | | |  | | | External error on the expansion module PNOZ m EF 8DI4DO or on the overall system. Expansion module is in a safe condition. |
|  |  | | |  | | Internal error on the inputs of the expansion module PNOZ m EF 8DI4DO. Expansion module is in a safe condition, e.g. pulse error. |
|  | | | | |  | Internal error on the outputs of the expansion module PNOZ m EF 8DI4DO. Expansion module is in a safe condition. |
|  | | | |  | | External error on the inputs of the expansion module PNOZ m EF 8DI4DO. Expansion module is in a safe condition. |
|  |  | | | |  | External error on the outputs of the expansion module PNOZ m EF 8DI4DO. Expansion module is in a safe condition, e.g. defective feedback loop. |
|  |  | | | |  | External error on the outputs of the expansion module PNOZ m EF 8DI4DO. Expansion module is in a safe condition, e.g. short across contacts. |

8 Technical details

| General | |
|---|---|
| Certifications | CE, EAC (Eurasian), KOSHA, TÜV, cULus Listed |
| Application range | Failsafe |
| Module's device code | 00E0h |
| Electrical data | |
| Supply voltage | |
| for | Supply to the SC outputs |
| Voltage | 24 V |
| Kind | DC |
| Voltage tolerance | -20 %/+25 % |
| Max. continuous current that the external power supply must provide | 8 A |
| Potential isolation | yes |
| Supply voltage | |
| for | Module supply |
| internal | Via base unit |
| Voltage | 24 V |
| Kind | DC |
| Current consumption | 39 mA |
| Power consumption | 1 W |
| Max. power dissipation of module | 4,5 W |
| Status indicator | LED |
| Permitted loads | inductive, capacitive, resistive |
| Inputs | |
| Number | 8 |
| Input voltage in accordance with EN 61131-2 Type 1 | 24 V DC |
| Input current at rated voltage | 5 mA |
| Input current range | 2,5 - 5,3 mA |
| Pulse suppression | 0,5 ms |
| Maximum input delay | 8 ms |
| Potential isolation | No |
| Semiconductor outputs | |
| Number of positive-switching single-pole semiconductor outputs | 4 |
| Switching capability | |
| Voltage | 24 V |
| Typ. output current at "1" signal and rated voltage of semiconductor output | 2 A |
| Permitted current range | 0,000 - 2,500 A |
| Residual current at "0" signal | 0,05 mA |
| Max. transient pulsed current | 12 A |
| Max. capacitive load | 1 µF |
| Max. internal voltage drop | 500 mV |

| Semiconductor outputs | |
|--|--------------------------------------|
| Max. duration of off time during self test | 330 µs |
| Switch-off delay | 3 ms |
| Potential isolation | yes |
| Short circuit-proof | yes |
| Environmental data | |
| Ambient temperature | |
| In accordance with the standard | EN 60068-2-14 |
| Temperature range | 0 - 60 °C |
| Forced convection in control cabinet off | 55 °C |
| Storage temperature | |
| In accordance with the standard | EN 60068-2-1/-2 |
| Temperature range | -25 - 70 °C |
| Climatic suitability | |
| In accordance with the standard | EN 60068-2-30, EN 60068-2-78 |
| Condensation during operation | Not permitted |
| Max. operating height above sea level | 2000 m |
| EMC | EN 61131-2 |
| Vibration | |
| In accordance with the standard | EN 60068-2-6 |
| Frequency | 5 - 150 Hz |
| Acceleration | 1g |
| Shock stress | |
| In accordance with the standard | EN 60068-2-27 |
| Acceleration | 15g |
| Duration | 11 ms |
| Airgap creepage | |
| In accordance with the standard | EN 61131-2 |
| Overvoltage category | II |
| Pollution degree | 2 |
| Protection type | |
| In accordance with the standard | EN 60529 |
| Housing | IP20 |
| Terminals | IP20 |
| Mounting area (e.g. control cabinet) | IP54 |
| Potential isolation | |
| Potential isolation between | SC output and system voltage |
| Type of potential isolation | Basic insulation |
| Rated insulation voltage | 30 V |
| Rated surge voltage | 2500 V |
| Mechanical data | |
| Mounting position | horizontally on mounting rail |
| DIN rail | |
| Top hat rail | 35 x 7,5 EN 50022 |
| Recess width | 27 mm |

Mechanical data

| | |
|---|---|
| Max. cable length | |
| Max. cable length per input | 1 km |
| Material | |
| Bottom | PC |
| Front | PC |
| Top | PC |
| Connection type | Spring-loaded terminal, screw terminal |
| Mounting type | plug-in |
| Conductor cross section with screw terminals | |
| 1 core flexible | 0,25 - 2,5 mm², 24 - 12 AWG |
| 2 core with the same cross section, flexible without crimp connectors or with TWIN crimp connectors | 0,2 - 1,5 mm², 24 - 16 AWG |
| Torque setting with screw terminals | 0,5 Nm |
| Conductor cross section with spring-loaded terminals: | |
| Flexible with/without crimp connector | 0,2 - 2,5 mm², 24 - 12 AWG |
| Spring-loaded terminals: Terminal points per connection | 2 |
| Stripping length with spring-loaded terminals | 9 mm |
| Dimensions | |
| Height | 101,4 mm |
| Width | 22,5 mm |
| Depth | 120 mm |
| Weight | 105 g |

Where standards are undated, the 2018-09 latest editions shall apply.

8.1 Safety characteristic data



NOTICE

You must comply with the safety characteristic data in order to achieve the required safety level for your plant/machine.

| Unit | Operating mode | EN ISO 13849-1: 2015 PL | EN ISO 13849-1: 2015 Category | EN 62061 SIL CL | EN 62061 PFH _D [1/h] | EN ISO 13849-1: 2015 T _M [year] |
|---------------|---|-------------------------|-------------------------------|-----------------|---------------------------------|--|
| Logic | | | | | | |
| CPU | 2-channel | PL e | Cat. 4 | SIL CL 3 | 2,84E-10 | 20 |
| Input | | | | | | |
| SC inputs | 1-channel | PL d | Cat. 2 | SIL CL 2 | 2,10E-09 | 20 |
| SC inputs | 2-channel | PL e | Cat. 4 | SIL CL 3 | 4,27E-11 | 20 |
| SC inputs | Short circuit-forming safety mats | PL d | Cat. 3 | SIL CL 2 | 1,80E-10 | 20 |
| SC inputs | 1-ch., pulsed light barrier | PL e | Cat. 4 | SIL CL 3 | 2,10E-10 | 20 |
| Output | | | | | | |
| SC outputs | 1-channel with advanced fault detection | PL e | Cat. 4 | SIL CL 3 | 2,12E-11 | 20 |
| SC outputs | 1-channel | PL d | Cat. 2 | SIL CL 2 | 2,29E-10 | 20 |
| SC outputs | 2-channel | PL e | Cat. 4 | SIL CL 3 | 1,64E-10 | 20 |

All the units used within a safety function must be considered when calculating the safety characteristic data.



INFORMATION

A safety function's SIL/PL values are **not** identical to the SIL/PL values of the units that are used and may be different. We recommend that you use the PAScal software tool to calculate the safety function's SIL/PL values.

8.2 Classification according to ZVEI, CB24I

The following tables describe the classes and specific values of the product interface and the classes of interfaces compatible with it. The classification is described in the ZVEI position paper "Classification of Binary 24 V Interfaces - Functional Safety aspects covered by dynamic testing".

| Input | |
|-------------------------------------|-----------------|
| Interfaces | |
| Drain | |
| Interface | Module |
| Class | C2 |
| Source | |
| Interface | Sensor |
| Class | C2, C3 |
| Drain parameters | |
| Test pulse duration, safety outputs | 500 µs |
| Min. input resistance | 5,6 kOhm |
| Max. capacitive load | 126 nF |
| Single-pole output | |
| Interfaces | |
| Source | |
| Interface | Module |
| Class | C2 |
| Drain | |
| Interface | Actuator |
| Class | C1, C2 |
| Source parameters | |
| Max. test pulse duration | 330 µs |
| Max. rated current | 2 A |
| Max. capacitive load | 1 µF |

9 Supplementary data

9.1 Permitted ambient temperature T_{amb} dependent on the total current I_{sum}

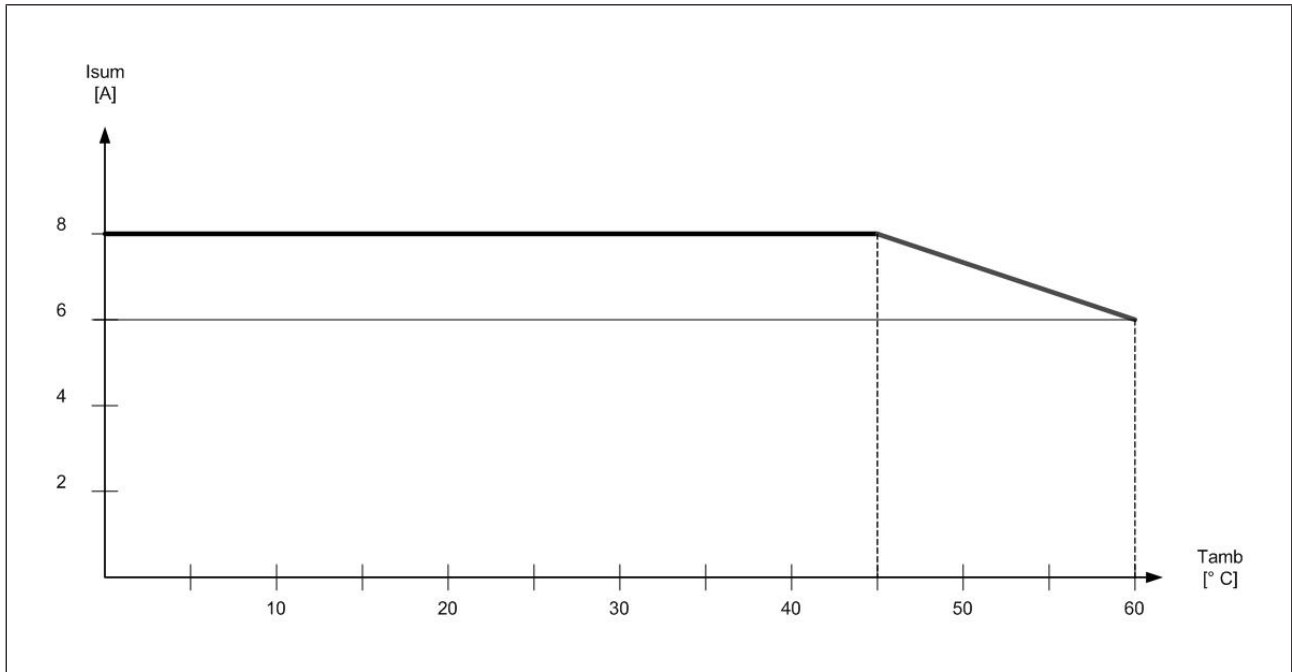

10 Order reference

10.1 Product

| Product type | Features | Order No. |
|------------------|------------------|-----------|
| PNOZ m EF 8DI4DO | Expansion module | 772 142 |

10.2 Accessories

Connection terminals

| Product type | Features | Order No. |
|----------------------|----------------------------------|-----------|
| Set spring terminals | 1 set of spring-loaded terminals | 751 004 |
| Set screw terminals | 1 set of screw terminals | 750 004 |

Terminator, jumper

| Product type | Features | Order no. |
|----------------------------|---|-----------|
| PNOZ mm0.xp connector left | Jumper yellow/black to connect the modules, 10 pieces | 779 260 |